

# ET16S-G

Media Server



**Specifications**

## Change History

Version	Release Date	Description
V1.3.0	2026-04-10	<ul style="list-style-type: none"><li>• Updated the rear panel picture and description.</li><li>• Updated the product selection section.</li><li>• Updated the optional items section.</li><li>• Updated the media file types and formats.</li></ul>
V1.2.1	2025-10-17	Changed HPG4500 Ada graphics card to HPG4500a.
V1.2.0	2025-08-31	<ul style="list-style-type: none"><li>• Changed HPG4000 graphics card to HPGA4000.</li><li>• Changed HPGA5000 graphics card to HPG4500 Ada.</li></ul>
V1.1.0	2024-11-30	<ul style="list-style-type: none"><li>• Updated the product selection section.</li><li>• Added the optional items section.</li></ul>
V1.0.0	2024-10-31	First release

## Introduction

The ET16S-G is a media server from NovaStar, boasting a 16K ultra-high resolution, pixel-to-pixel screen loading, and multiple high-performance graphics cards.

Equipped with a powerful workstation motherboard, Intel Xeon processor, and ECC high-speed memory, the ET16S-G enables flawless frame-synchronized output of four graphics cards. A single media server can replace four traditional media servers with single graphics card configurations, while also having the ability to link multiple servers for frame-synchronized mosaic and backup, perfect for meeting the requirements of ultra-high resolution displays exceeding 16K.

Incorporating the latest version of Kompass FX3 multimedia playback software, the ET16S-G showcases its ability to hardware decode up to four channels of 8K60fps high-definition video content simultaneously, giving full play to the decoding and rendering capabilities of all available GPUs. Furthermore, it offers a range of functionalities, including multi-channel audio and video playback and processing, visual media management and program arrangement, as well as output partitioning and reorganization, enabling seamless control and creative display in mosaic configurations using multiple graphics cards.

With all these advanced features, the ET16S-G is well-suited for various fixed installation scenarios requiring exceptional resolution and powerful playback control, such as large-scale outdoor advertising displays, naked-eye 3D, immersive experiences, data centers, and exhibition showcases.

## Certifications

CE, FCC, IC, CB, KC, RoHS

**If the product does not have the relevant certifications required by the countries or regions where it is to be sold, please contact NovaStar to confirm or address the problem.**

**Otherwise, the customer shall be responsible for the legal risks caused or NovaStar has the right to claim compensation.**

## Features

- A single device supports up to 16K×8K output capacity, ultra-high resolution video decoding and pixel-to-pixel display
- Splitting, reorganization, and rotation of multiple outputs, enabling loading of irregular displays and achieving creative mosaic display
- Dividing output into up to 64 partitions, accommodating ultra-wide screens and rapid mapping adjustments
- HDR output support
- Hardware decoding support
- NDI sources, website page sources, sources from capture devices, streaming media sources and text sources support
- Multi-screen management and control
- Simultaneous playback of up to 12x layers and 1x audio
- Adjustable layer size and priority
- Layer keying, blurring, opacity, mask and cropping adjustments
- Visualized program arrangement and management
- Live and pre-edit modes
  - The program editing and playback are in sync in live mode
  - Edit the programs before displaying them on the screen in pre-edit mode

- Media library management, including videos, pictures, Office files and audios
- Media file grouping and sorting
- Media file batch import
- Media collection configurations
- Playback progress management
- Program jumping and auto jumping settings
- PowerPoint files, streaming media and webpage playback
- Laser pointer control for PowerPoint file playback
- Main KV and main KV jumping
- Crossfade on program switching
- One-click FTB
- Auto startup of built-in software on system power on
- Auto program playback on software startup
- Controlled via NovaStar's Visual Intelligent Control Platform (VICP), enabling a highly efficient and user-friendly control experience

## Appearance

### Note

All product pictures shown in this document are for illustration purpose only. Actual product may vary.

### Front Panel



No.	Area	Function
1	Power button	Turn on or turn off the device.
2	USB	2x USB 3.0 <ul style="list-style-type: none"> <li>• Connect to the mouse and keyboard.</li> <li>• Insert a USB drive for importing media files.</li> </ul>

**Rear Panel**

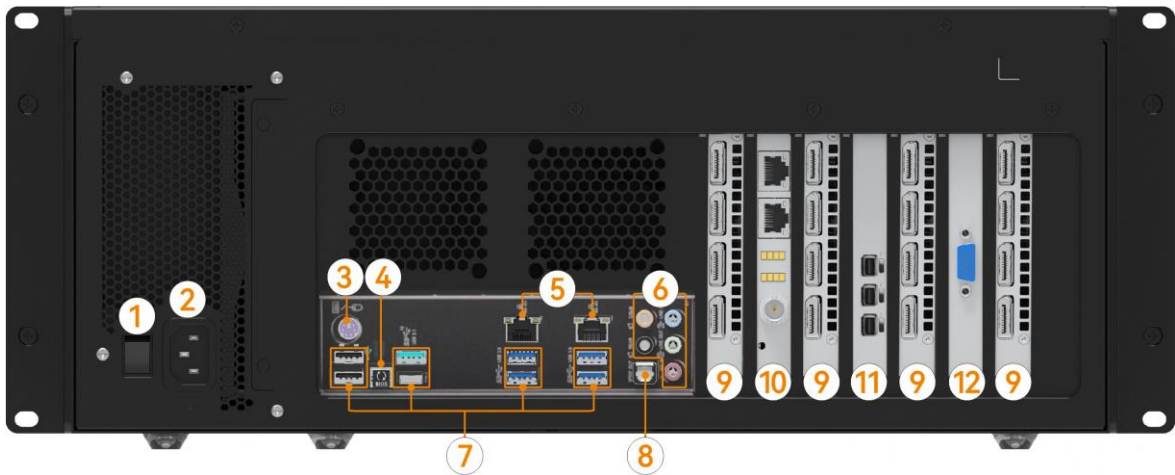

**Note**

The number of output connectors on the rear panel varies depending on the quantity of graphics cards installed.

No.	Area	Description
1	Power button	Power on or power off the device.
2	Power	Connect to an external power source.
3	PS/2	Connect to the mouse and keyboard.
4	USB BIOS Flashback button	For the BIOS program update of the motherboard
5	RJ45	2x RJ45 connectors for Ethernet networking
6	3.5 mm audio	<ul style="list-style-type: none"> <li>• 1x MIC IN: 3.5 mm microphone input connector</li> <li>• 1x Line IN: 3.5 mm external audio input connector</li> <li>• 3x Line OUT: 3.5 mm audio output connectors for 6 channel connections</li> </ul>

No.	Area	Description
7	USB	<p>Connect to the mouse and keyboard or insert a USB drive.</p> <ul style="list-style-type: none"> <li>• 2x Type-A USB 2.0</li> <li>• 1x Type-A USB 3.1 Gen2</li> <li>• 1x Type-C USB 3.1 Gen2</li> <li>• 4x Type-A USB 3.1 Gen1</li> </ul>
8	Optical port	S/PDIF digital audio output
9	Output	<p>4x DP 1.4</p> <ul style="list-style-type: none"> <li>• Up to 4x 5120×2880@60Hz outputs</li> <li>• Four connector mosaic output, with a maximum total width or height of 16384 pixels</li> <li>• Single connector width: 480–8192 pixels</li> <li>• Single connector height: 300–8192 pixels</li> </ul> <p> Note</p> <ul style="list-style-type: none"> <li>• The graphics card does not support irregular mosaic layouts. The mosaic layout must be 1×2, 1×3, 1×4, 2×2, 2×1, 3×1 or 4×1.</li> <li>• The output resolutions of the graphics card connectors that are used for mosaic must be the same.</li> <li>• Up to 4 graphics cards can be configured for video output.</li> </ul>
10	Sync card	<ul style="list-style-type: none"> <li>• 2x RJ45 Accept a frame lock signal and output the signal.</li> <li>• 1x BNC Accept an external sync signal.</li> <li>• LED indicators Indicate the statuses of the sync signal connections.</li> </ul>
11	Control UI (MPGT400)	<p>3x Mini DP</p> <ul style="list-style-type: none"> <li>• Max single connector output: 4096×2160@60Hz</li> <li>• Connect to a monitor for displaying the software user interface.</li> </ul>
12	VGA	<p>1x VGA</p> <p>Only used for display software interface and system installation during production</p>



## Product Selection

The media server is available in different mainframe models. Please refer to the configuration information in the table below for your selection.

Model	Configuration	Graphics Card	Sync Card	Capture Card
ET16S-G(2A4) Mainframe	<ul style="list-style-type: none"> <li>• Processor: 1x Intel Xeon Gold Processor</li> <li>• Memory: 64 GB (default), expandable</li> <li>• Hard drive: 1 TB high-speed SSD (default)</li> <li>• 8x DP cables</li> </ul>	2x HPGA4000  Single card spec: <ul style="list-style-type: none"> <li>• Smooth playback of 1x hardware-decoded 8K×4K@60fps SDR video files</li> <li>• Memory: 16 GB</li> <li>• Type: GDDR6</li> <li>• Bit width: 256-bit</li> </ul>	1x Sync card 2	No support
ET16S-G(3A4) Mainframe	<ul style="list-style-type: none"> <li>• Processor: 2x Intel Xeon Gold Processors</li> <li>• Memory: 128 GB (default), expandable</li> <li>• Hard Drive: 1 TB + 960 GB high-speed SSDs (default)</li> <li>• 12x DP cables</li> </ul>	3x HPGA4000  Single card spec: <ul style="list-style-type: none"> <li>• Smooth playback of 1x hardware-decoded 8K×4K@60fps SDR video files</li> <li>• Memory: 16 GB</li> <li>• Type: GDDR6</li> <li>• Bit width: 256-bit</li> </ul>	1x Sync card 2	Optional, select at most 1  For detailed information, please refer to Optional Items.
ET16S-G(4A4) Mainframe	<ul style="list-style-type: none"> <li>• Processor: 2x Intel Xeon Gold Processors</li> <li>• Memory: 128 GB (default), expandable</li> <li>• Hard Drive: 1 TB + 960 GB high-speed SSDs (default)</li> <li>• 16x DP cables</li> </ul>	4x HPGA4000  Single card spec: <ul style="list-style-type: none"> <li>• Smooth playback of 1x hardware-decoded 8K×4K@60fps SDR video files</li> <li>• Memory: 16 GB</li> <li>• Type: GDDR6</li> <li>• Bit width: 256-bit</li> </ul>	1x Sync card 2	No support

## Optional Items

The following table lists the optional items that you need to purchase from NovaStar separately.

Type	Description
ET16S_4-Channel 12G_SDI Capture Card	 <p>4x 12G-SDI</p> <ul style="list-style-type: none"> <li>• Compatible with 6G-SDI and 3G-SDI</li> <li>• Max resolution of single connector: 4096×2160@60Hz</li> <li>• Max width: 4096 pixels, max height: 4096 pixels</li> <li>• Support for simultaneous access to 4 video inputs.</li> </ul>
4-Channel HDMI 2K60 Capture Card	 <p>4x HDMI</p> <ul style="list-style-type: none"> <li>• Max resolution of single connector: 1920×1080@60Hz</li> <li>• Support for simultaneous access to 4 video inputs.</li> </ul>
ET16S_4-Channel HDMI 4K60 Capture Card	 <p>4x HDMI 2.0</p> <ul style="list-style-type: none"> <li>• Max resolution of single connector: 4096×2160@60Hz</li> <li>• Support for simultaneous access to 4 video inputs.</li> </ul>

## Applications

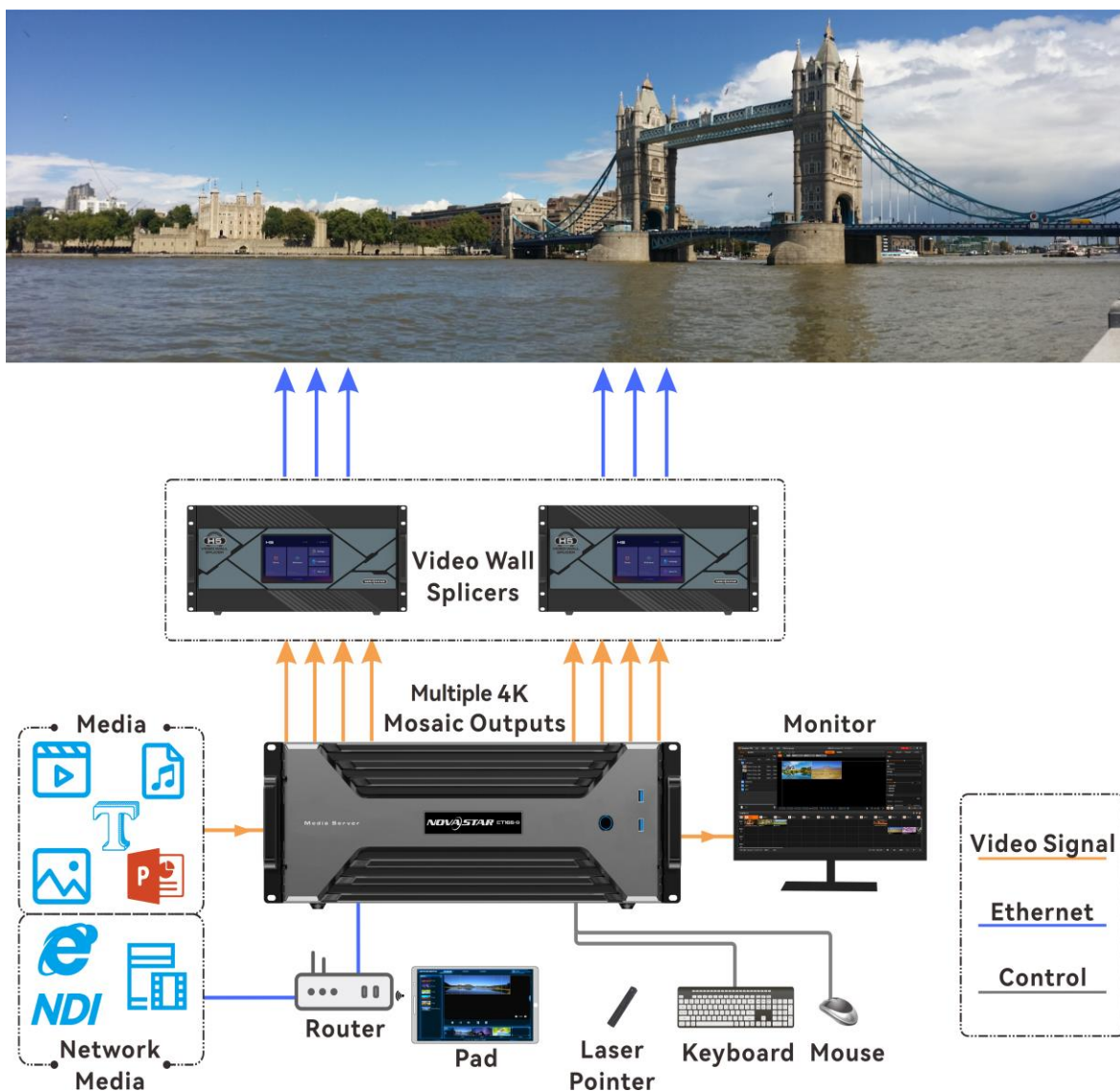

**Note**

- This product can only be placed horizontally. Do not mount vertically or upside-down.
- The product can be mounted in a standard 19-inch rack capable of withstanding at least four times the total weight of the mounted equipment. Four M5 screws should be used to fix the product.

## Dimensions

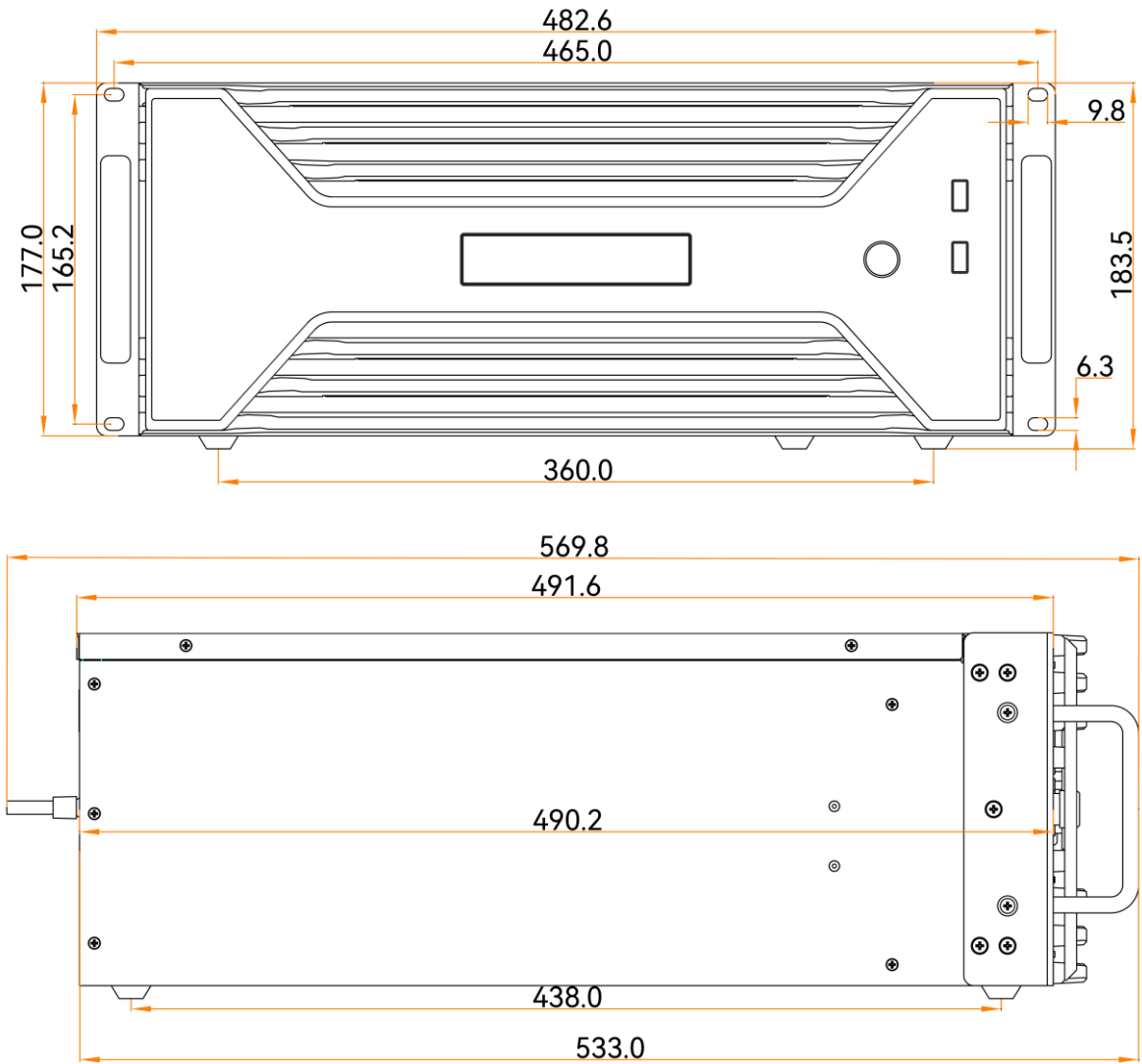

Tolerance:  $\pm 0.5$  Unit: mm

## Specifications

### Hardware/Software

CPU	Intel Xeon Gold Processor
Memory	ECC DDR4 high-speed memory
Hard drive	High-speed SSD
Motherboard	High-performance workstation motherboard
Power supply	1300 W
Keyboard & Mouse	Keyboard and mouse suit
OS	Windows 10 Enterprise LTSC
Built-in software	Kompass FX3 multimedia playback and control software with licensing dongle

### General Specifications

Electrical Characteristics	Power connector	100-240V~ 10-8A 47-63Hz
	Max power consumption	1100 W
Operating Environment	Temperature	0°C to +40°C
	Humidity	0% RH to 80% RH, non-condensing
Storage Environment	Temperature	-10°C to +60°C
	Humidity	0% RH to 95% RH, non-condensing
Physical Specifications	Dimensions	482.6 mm × 183.5 mm × 569.8 mm
	Net weight	17.9 kg
	Gross weight	24.5 kg
Packing Information	Accessories	1x Power cable 1x Mini DP to HDMI cable 1x VGA to HDMI cable 1x Keyboard and mouse suit 1x Certificate of Approval 1x Safety Manual

		 <b>Note</b> Cables and adapters from the product selection are not included in this packing list.
	Packing dimensions	735 mm × 660 mm × 300 mm

## Media File Types and Formats

### Media Types

The media server supports the decoding of various common video coding formats, such as H.264 (AVC), H.265 (HEVC), MPEG-4/2 and WMV.

Type	Format
Video	avi, asf, wmv, flv, mkv, mov, 3gp, mp4, mpg, mpeg, ts, m4v, webm, nvf, m2ts
Image	jpg, bmp, gif, png, jpeg, ico
Audio	wav, mp3, wma, ape, aac, flac, ogg, dts, amr, alac
Office	ppt, excel, word, pdf

 **Note**

Recommended video coding formats:

- 4K < resolutions ≤ 8K, width or height ≤ 8192 pixels: H.265 (HEVC) or VP9 recommended
- Resolutions ≤ 4K: H.264 (AVC) recommended
- When the video size exceeds 8K, it is recommended to split the video into multiple files for playback.

## Video Source Specifications

- In single media server setup, the recommended frame rates and bitrates are as followings:

Type	Standard Frame Rate	Bitrate	High Frame Rate	Bitrate
4320 (8K)	24 Hz, 25 Hz, 30 Hz	75 to 90 Mbps	48 Hz, 50 Hz, 60 Hz	110 to 135 Mbps
2160 (4K)		35 to 45 Mbps		53 to 68 Mbps
1440 (2K)		16 Mbps		24 Mbps
1080p		8 Mbps		12 Mbps

- In multi-media server setup, the recommended frame rates and bitrates are as followings:

Type	Frame Rate	Video Bitrate	Video Coding
4320 (8K)	60 Hz	30 Mbps	H.265
2160 (4K)	60 Hz	30 Mbps	H.264

### Note

If frame synchronization output is not required in a multi-media server setup, please refer to the recommended frame rates and bitrates for single media server setup.

## Notes and Cautions

### Notes For Battery

- The battery is not intended to be replaced.
- Disposal of a battery into fire or a hot oven, or mechanically crushing or cutting of a battery can result in an explosion.
- Leaving a battery in an extremely high temperature surrounding environment can result in an explosion or the leakage of flammable liquid or gas.
- A battery subjected to extremely low air pressure may result in an explosion or the leakage of flammable liquid or gas.

### FCC Caution

Any changes or modifications not expressly approved by the party responsible for compliance could void the user's authority to operate the equipment.

This device complies with part 15 of the FCC Rules. Operation is subject to the following two conditions: (1) This device may not cause harmful interference, and (2) this device must accept any interference received, including interference that may cause undesired operation.

Note: This equipment has been tested and found to comply with the limits for a Class A digital device, pursuant to part 15 of the FCC Rules. These limits are designed to provide reasonable protection against harmful interference when the equipment is operated in a commercial environment. This equipment generates, uses, and can radiate radio frequency energy and, if not installed and used in accordance with the instruction manual, may cause harmful interference to radio communications. Operation of this equipment in a residential area is likely to cause harmful interference in which case the user will be required to correct the interference at his own expense.

### Others

This is Class A product. In a domestic environment, this product may cause radio interference in which case the user may be required to take adequate measures.

## Copyright

**Copyright © 2026 Xi'an NovaStar Tech Co., Ltd. All Rights Reserved.**

No part of this document may be copied, reproduced, extracted or transmitted in any form or by any means without the prior written consent of Xi'an NovaStar Tech Co., Ltd.

**Trademark**

 is a trademark of Xi'an NovaStar Tech Co., Ltd.

**Statement**

Thank you for choosing NovaStar's product. This document is intended to help you understand and use the product. For accuracy and reliability, NovaStar may make improvements and/or changes to this document at any time and without notice. If you experience any problems in use or have any suggestions, please contact us via the contact information given in this document. We will do our best to solve any issues, as well as evaluate and implement any suggestions.

| [Official website](http://www.novastar.tech)  
| [www.novastar.tech](http://www.novastar.tech)

| [Technical support](mailto:support@novastar.tech)  
| [support@novastar.tech](mailto:support@novastar.tech)